

GYMSTICK™

GYMSTICK HOME GYM 2 (STR-HG2)

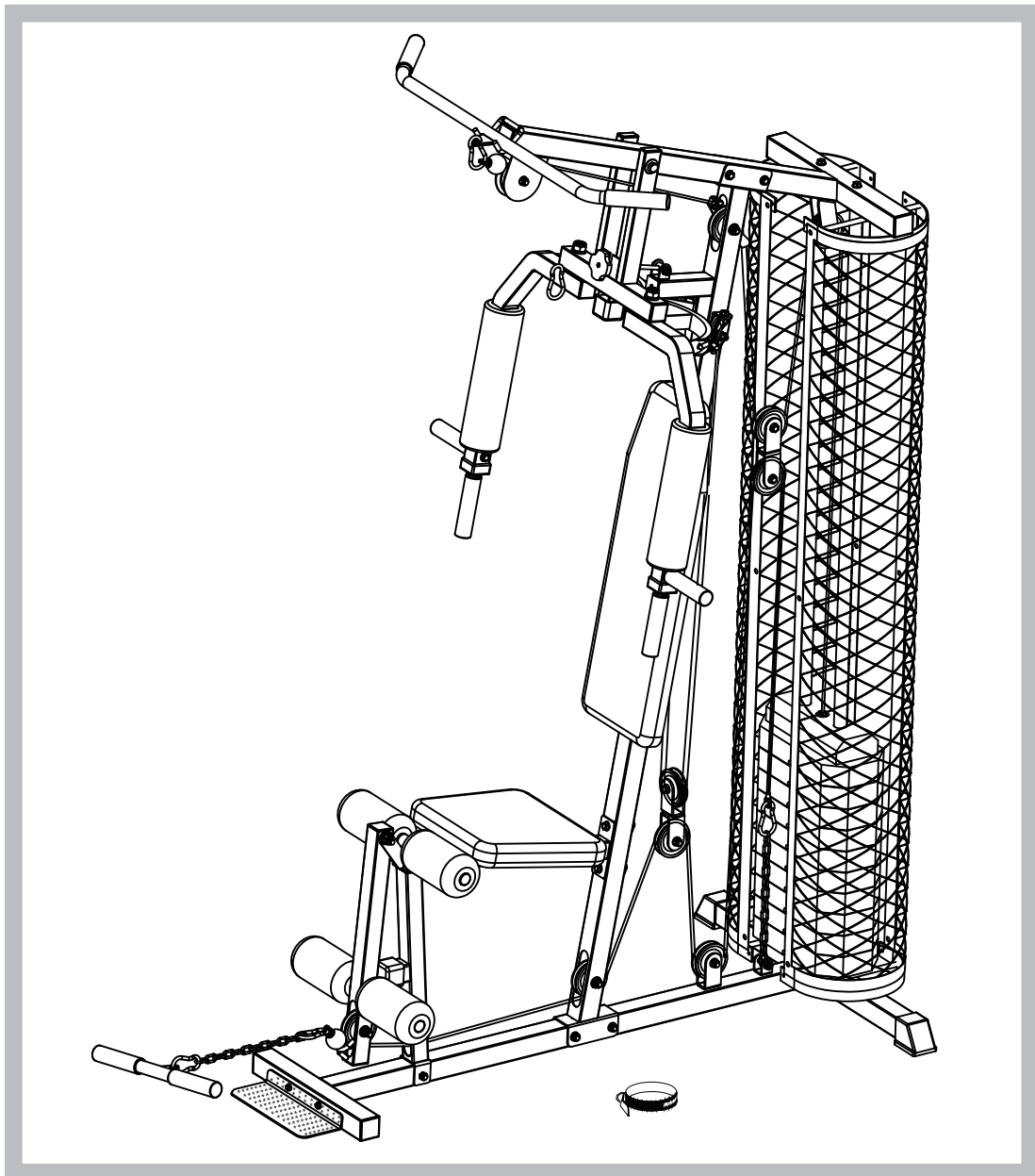





OWNER'S MANUAL (ENGLISH)



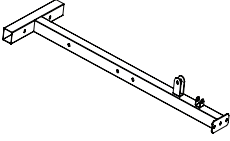
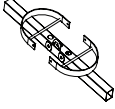
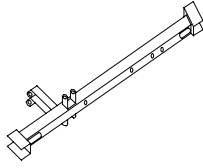
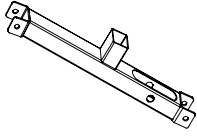
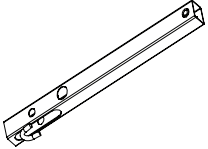
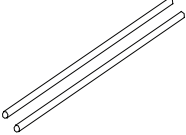
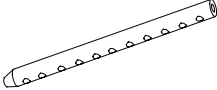
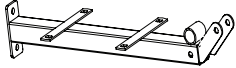
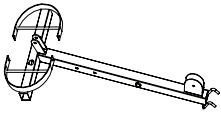
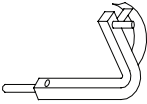
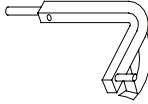
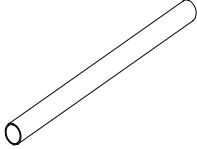
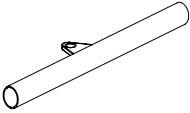
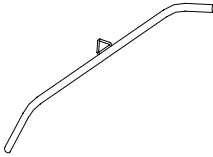
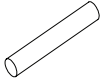
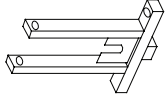
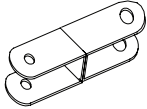
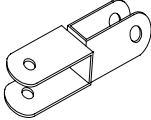
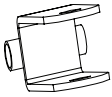

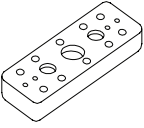
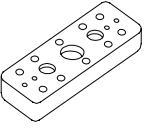
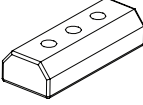





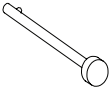

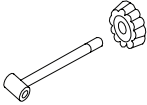
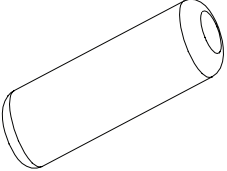
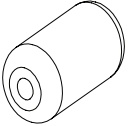
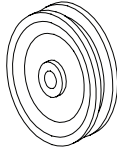



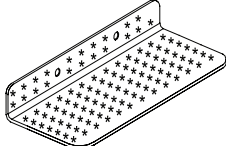

INDEX

HARDWARE PARTS LIST	page 1-3
ASSEMBLY STEPS	page 4-15
EXPLODED DRAWING	page 16
PARTS LIST	page 17
IMPLIED WARRANTY	page 18



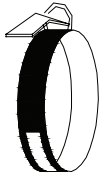
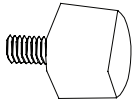







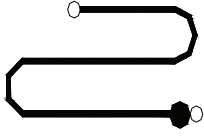
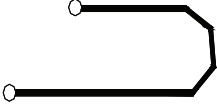
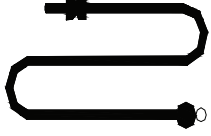
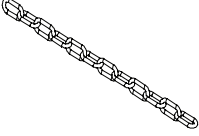



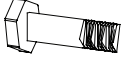
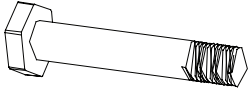
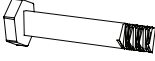

HARDWARE PARTS LIST

 <p>HG2-01 Front Base Frame 1 pc</p>	 <p>HG2-02 Back Base Frame 1 pc</p>	 <p>HG2-03 Main Fame 1 pc</p>	 <p>HG2-04 Front Support Frame 1 pc</p>	
 <p>HG2-05 Leg Extension Frame 1 pc</p>	 <p>HG2-06 Weight Guide Tube 2 pcs</p>	 <p>HG2-07 Selector Shaft 1 pc</p>	 <p>HG2-08 Seat Frame 1 pc</p>	
 <p>HG2-09 Upper Cross Beam 1 pc</p>	 <p>HG2-10 Press Arm (Right) 1 pc</p>	 <p>HG2-11 Press Arm (Left) 1 pc</p>	 <p>HG2-12 Foam Pipe 2 pcs</p>	
 <p>HG2-13 Low Pull 1 pc</p>	 <p>HG2-14 High Pull 1 pc</p>	 <p>HG2-15 Hand Bar 2 pcs</p>	 <p>HG2-16 Press bar 1 pc</p>	
 <p>HG2-17 Pulley U 1 pc</p>	 <p>HG2-18 Reverse U 1 pc</p>	 <p>HG2-19 Volitant U 2 pcs</p>	 <p>HG2-20 Seat Cushion 1 pc</p>	
 <p>HG2-21 Back Cushion 1 pc</p>	 <p>HG2-22a Weight Plate 6.8kg 9 pcs</p>	 <p>HG2-22b Weight Plate 4.5kg 1 pc</p>	 <p>HG2-23 Top Weight Plate 1 pc</p>	 <p>HG2-24 Selector Shaft Pin ($\varnothing 10 \times 56\text{mm}$) 1 pc</p>

HARDWARE PARTS LIST

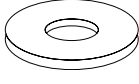
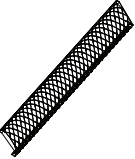
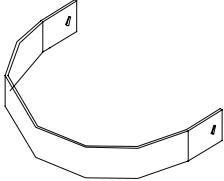
 <p>HG2-25 Selector Shaft Bush 1 pc</p>	 <p>HG2-26 Weight Selector Pin 1 pc</p>	 <p>HG2-27 Rubber Cushion 2 pcs</p>	 <p>HG2-28 Press Pin 1 pc</p>
 <p>HG2-29 Big Foam 2 pcs</p>	 <p>HG2-30 Small Foam 4 pcs</p>	 <p>HG2-31 Pulley 13 pcs</p>	 <p>HG2-32 Square End Plug (38mm) 4 pcs</p>
 <p>HG2-33 Hand Bar Grip 8 pcs</p>	 <p>HG2-34 Middle-empty Plug 2 pcs</p>	 <p>HG2-35 Base Plate 1 pc</p>	 <p>HG2-36 Outside-end Plug (45mm) 2 pcs</p>
 <p>HG2-37 Pulley Fastness Bush (big) 4 pcs</p>	 <p>HG2-38 Pulley Fastness Bush (small) 4 pcs</p>	 <p>HG2-39 Square End Plug (45mm) 5 pcs</p>	 <p>HG2-40 Square End Plug (40mm) 2 pcs</p>
 <p>HG2-41 End Plug (40 x 20 mm) 2 pcs</p>	 <p>HG2-42 End Plug (ø25) 4 pcs</p>	 <p>HG2-43 Ankle Strap 1 pc</p>	 <p>HG2-44 Rubber Bumper 1 pc</p>
 <p>HG2-45 Square Outside-end Plug (38mm) 2 pcs</p>	 <p>HG2-46 Round Plug 2 pcs</p>	 <p>HG2-47 Pothook 4 pcs</p>	 <p>HG2-48 Oil Bush (big) 4 pcs</p>

HARDWARE PARTS LIST

 <p>HG2-49 Oil Bush (small) 2 pcs</p>	 <p>HG2-50 Cable (3750mm) 1 pc</p>	 <p>HG2-51 Cable (2720mm) 1 pc</p>	 <p>HG2-52 Cable (2330mm) 1 pc</p>	
 <p>HG2-53 Chain 2 pcs</p>	 <p>HG2-54 Hex Bolt (M10 x 20mm) 6 pcs</p>	 <p>HG2-55 Hex Bolt (M8 x 15mm) 4 pcs</p>	 <p>HG2-56 Hex Bolt (M10 x 65mm) 13 pcs</p>	
 <p>HG2-57 Hex Bolt (M10 x 60mm) 6 pcs</p>	 <p>HG2-58 Hex Bolt (M10 x 45mm) 9 pcs</p>	 <p>HG2-59 Hex Bolt (M12 x 120mm) 1 pc</p>	 <p>HG2-60 Hex Bolt (M8 x 65mm) 2 pcs</p>	
 <p>HG2-61 Hex Bolt (M8 x 40mm) 2 pcs</p>	 <p>HG2-62 Washer (M12) 4 pcs</p>	 <p>HG2-63 Washer (M10) 62 pcs</p>	 <p>HG2-64 Washer (M8) 10 pcs</p>	
 <p>HG2-65 Nylock Nut (M12) 3 pcs</p>	 <p>HG2-66 Nylock Nut (M10) 28 pcs</p>	 <p>HG2-67 Nylock Nut (M8) 2 pcs</p>	 <p>HG2-68 Plastic Washer 1 pc</p>	
 <p>HG2-69 Convoy 2 pcs</p>	 <p>HG2-70 Convoy Connect 2 pcs</p>	 <p>HG2-71 Hex Bolt (M6 x 15mm) 12 pcs</p>	 <p>HG2-72 Washer (M6) 24 pcs</p>	 <p>HG2-73 Nylock Nut (M6) 12 pcs</p>





ASSEMBLY STEPS

COMPLETE EACH STAGE IN ORDER BEFORE ADVANCING TO TO THE NEXT.
 ASSEMBLE WITH NUTS AND BOLTS LOOSE AT FIRST
 TIGHTEN ALL BOLTS AND NUTS AFTER COMPLETING ALL ASSEMBLY STEPS.

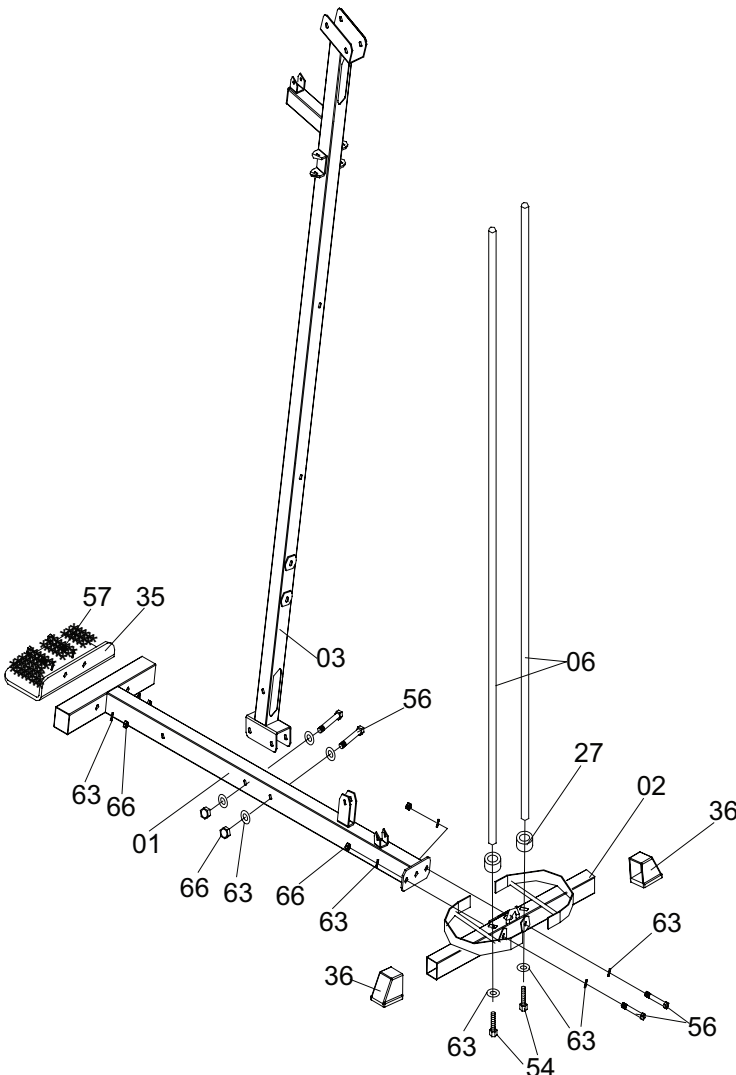
STEP 1

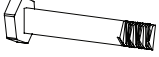
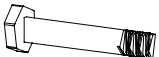
- Lay the **Back Base Frame** (02) flat on the floor. Put two **Outside-End Caps** (36) to **Back Base Frame** (02). Slide two **Rubber Cushions** (27) down **Weight Guide Tubes** (06). Insert the 2 **Weight Guide Tubes** (06) into the 2 outer holes in the **Back Base Frame** (02), secure them with two M10x20mm **Hex Bolts** (54), two M10 **Washers** (63).
- Connect the **Front Base Frame** (01) and the **Back Base Frame** (02) together using two M10x65mm **Hex Bolts** (56), four M10 **Washers** (63) and two M10 **Nylock Nuts** (66).
- Connect the **Main Frame** (03) and the **Front Base Frame** (01) together using two M10x65mm **Hex Bolts** (56), four M10 **Washers** (63) and two M10 **Nylock Nuts** (66).
- Connect the **Base Plate** (35) and the **Front Base Frame** (01) together using two M10x60mm **Hex Bolts** (57), four M10 **Washers** (63) and two M10 **Nylock Nuts** (66).





No.	Description	Q'ty
HG2-56	 Hex Bolt (M10x65mm)	4
HG2-57	 Hex Bolt (M10x60mm)	2
HG2-63	 Washer (M10)	14
HG2-66	 Nylock Nut (M10)	6
HG2-54	 Hex Bolt (M10x20mm)	2
HG2-27	 Rubber Cushion	2

ASSEMBLY STEPS

STEP 2

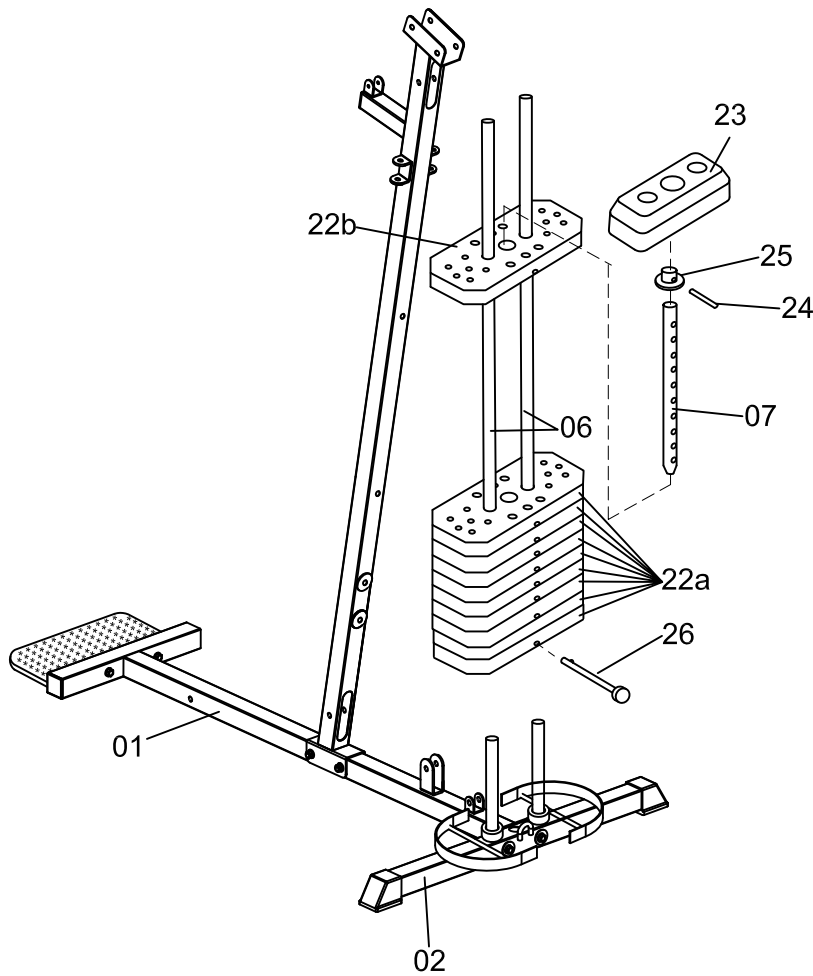
- Slide nine **Weight Plates 6.8kg** (22a) and one **Weight Plates 4.5kg** (22b) onto **Weight Guide Tube** (6).
- Attach the **Selector Shaft Bush** (25) onto the top hole of the **Selector Shaft** (07) using **Selector Shaft Pin** (24). Slide the **Top Weight Plate** (23) onto the **Weight Guide Tubes** (06) and locate the **Selector Shaft** (07) in position, setting the **Top Weight Plate** (23) onto the top of the **Weight Plate** (22). Use the **Weight Selector Pin** (26) to select the desire weight.



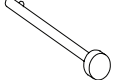





No.	Description	Q'ty
HG2-24	 Selector Shaft Pin ($\varnothing 10 \times 56 \text{mm}$)	1
HG2-25	 Selector Shaft Bush	1
HG2-26	 Weight Selector Pin	1

ASSEMBLY STEPS

STEP 3

- Lay the **Upper Cross Beam** (09) onto the **Main Frame** (03) and connect them using two M10x65mm **Hex Bolts** (56), four M10 **Washers** (63) and two M10 **Nylock Nuts** (66).
- Connect the **Weight Guide Tube** (06) to the **Upper Cross Beam** (09) using two M10x20mm **Hex Bolt** (54), two M10 **Washers** (63).
- Connect the **Press Pin** (28) to the **Main Frame** (03) using M8 x 40 mm **Hex Bolts** (61), two M8 **Washers** (64) and M8 **Nylock Nuts** (67).
- Connect the **Volitant U** (19) to the **Main Frame** (03) using two M10 x 65mm **Hex Bolt** (56), four M10 **Washers** (63) and two M10 **Nylock Nuts** (66).

No.	Description	Q'ty
HG2-56	 Hex Bolt (M10x65mm)	4
HG2-54	 Hex Bolt (M10x20mm)	2
HG2-61	 Hex Bolt (M8x40mm)	1
HG2-63	 Washer (M10)	10
HG2-66	 Nylock Nut (M10)	4
HG2-64	 Washer (M8)	2
HG2-67	 Nylock Nut (M8)	1

ASSEMBLY STEPS

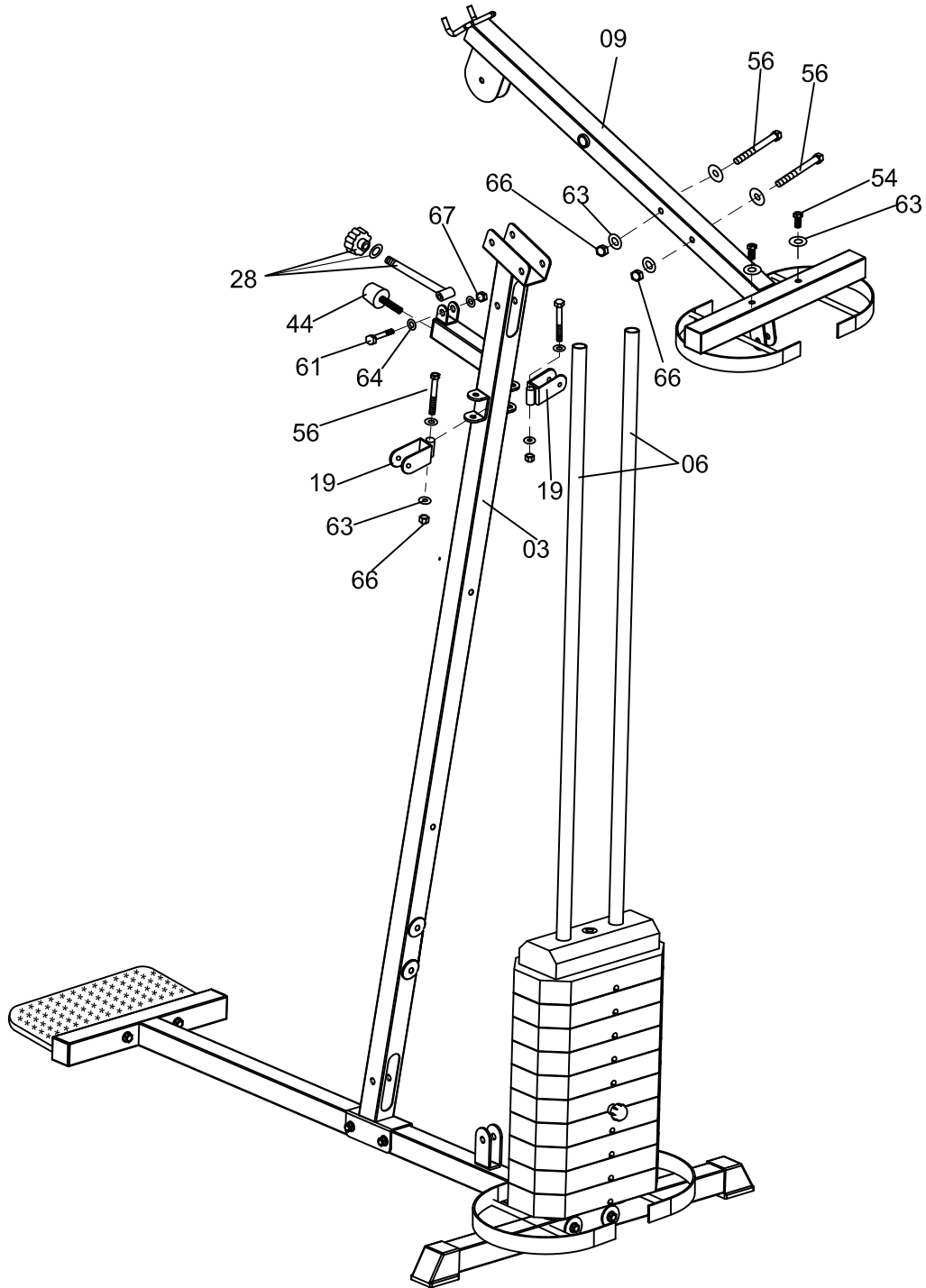





ASSEMBLY STEPS

STEP 4

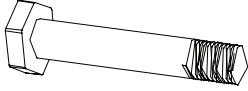
- Connect the **Press Bar** (16) to the **Upper Cross Beam** (09) using M12x120mm **Hex Bolt** (59), two M12 **Washers** (62), and M12 **Nylock Nuts** (65).
- Connect the **Press Arm** (L) (11) and **Press Arm** (R) (10) to the **Press Bar** (16) using two M12 **Washers** (62) and two M12 **Nylock Nuts** (65).
- Slide the two **Big Foam** (29) onto the **Press Arm** (R) (10) and **Press Arm** (L) (11), attach the two **Handle Bar Grip** (33) through two **Mid-Empty Plug** (34) to the **Press Arm** (R) (10).
- Connect the two **Hand Bar** (15) to the **Press Arm** (L) (11) and **Press Arm** (R) (10) using two M10x20mm **Hex Bolts** (54) and two M10 **Washers** (63).

Note: 1. Cut off the PVC straps on **Oil Bush (big)** (48) and **Oil Bush (small)** (49) before proceeding with Step 4.
 2. A hammer may be required to tap **Oil Bush (big)** (48) and **Oil Bush (small)** (49) into place.
 3. Use small amount of washing up liquid to aid assembly **Big foam** (29).

No.	Description	Q'ty
HG2-59	 Hex Bolt (M12x120mm)	1
HG2-62	 Washer (M12)	4
HG2-65	 Nylock Nut (M12)	3
HG2-54	 Hex Bolt (M10x20mm)	2
HG2-63	 Washer (M10)	2



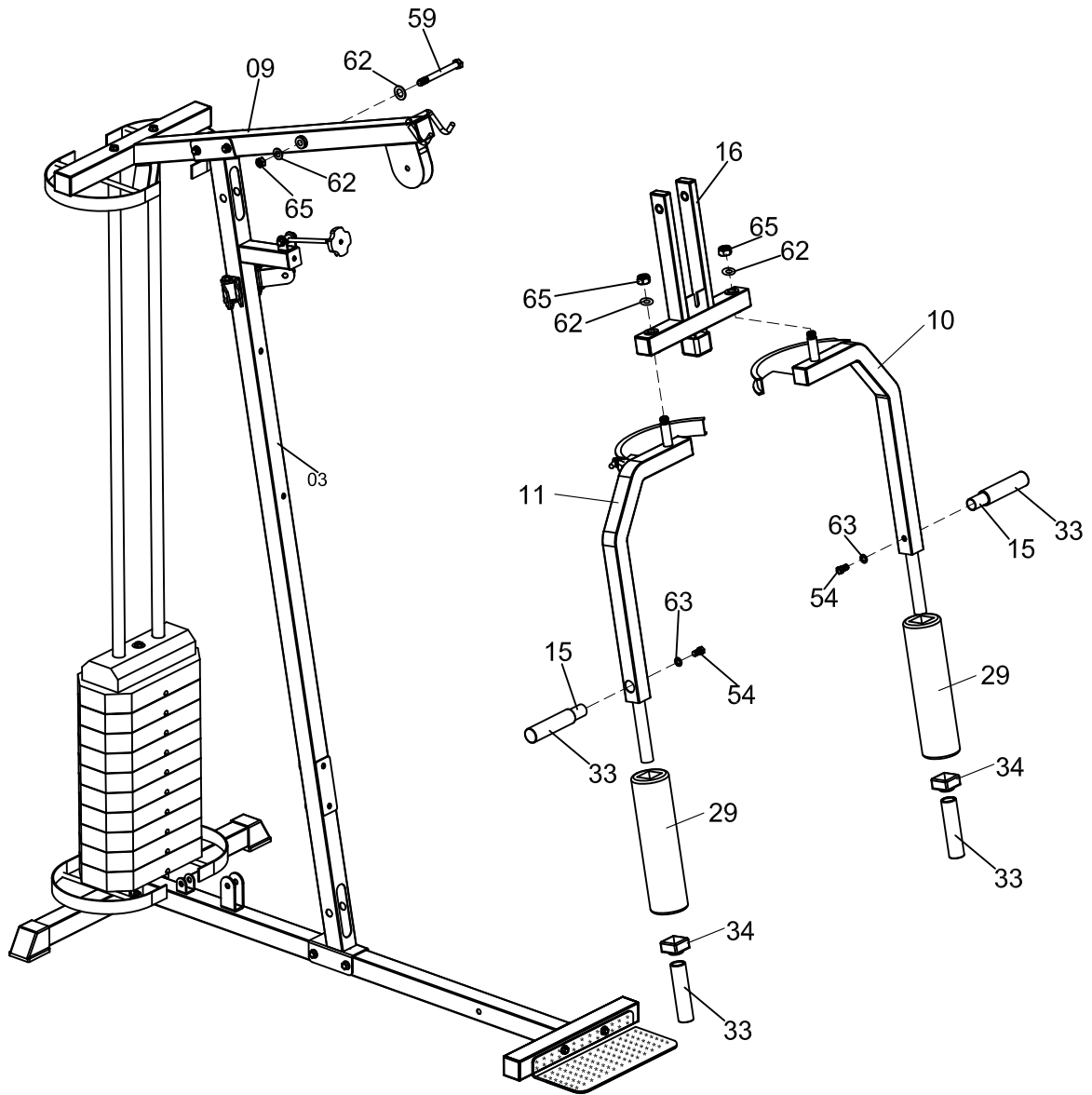



ASSEMBLY STEPS



ASSEMBLY STEPS

STEP 5

- Fit the **Back Cushion** (21) to the **Main Frame** (03) using two M8 x65mm **Hex Bolts** (60) and two M8 **Washers** (64).
- Connect the **Front Support Frame** (04) to the **Front Base Frame** (01) using M10x65mm **Hex Bolt** (56), two M10 **Washers** (63) and M10 **Nylock Nut** (66).
- Connect the **Seat Frame** (08) to the **Main Frame** (03) and the **Front Support Frame** (04) using two M10x65mm **Hex Bolts** (56), M10x60mm **Hex Bolt** (57), six M10 **Washers** (63) and three M10 **Nylock Nuts** (66).
- Connect the **Leg Extension Frame** (05) to the **Seat Frame** (08) using M10x60mm **Hex Bolt** (57), two M10 **Washers** (63) and M10 **Nylock Nut** (66).
- Fit the **Seat Cushion** (20) to the **Seat Frame** (08) using four M8x15mm **Hex Bolts** (55) and four M8 **Washers** (64).
- Insert the **Foam Pipes** (12) into the hole of the **Leg Extension Frame** (05), then attach two **Small Foam** (30) to **Foam Pipe** (12).
- Insert the **Foam Pipes** (12) into the hole of the **Seat Frame** (08), then attach two **Small Foam** (30) to **Foam Pipe** (12).

No.	Description	Q'ty
HG2-60	 Hex Bolt (M8x65mm)	2
HG2-64	 Washer (M8)	6
HG2-66	 Nylock Nut (M10)	5
HG2-63	 Washer (M10)	10
HG2-56	 Hex Bolt (M10x65mm)	3
HG2-55	 Hex Bolt (M8x15mm)	4
HG2-57	 Hex Bolt (M10x60mm)	2

ASSEMBLY STEPS

STEP 6

1. Start With The Upper Cable 2330mm (52)

- (a) With **Upper Cable** (52) in groove of **Pulley** (31), thread **Upper Cable** (52) through brackets on **Upper Cross Beam** (09).
- (b) Install **Pulley** No.1 (31) to **Upper Cross Beam** (09) using one M10x45mm **Hex Bolt** (58), two M10 **Washers** (63) and one M10 **Nylock Nut** (66).
- (c) Install **Pulley** No.2 (31) with two **Pulley Fastness Bush** (Big) (37) to **Main Frame** (03) using one M10x65mm **Hex Bolt** (56), two M10 **Washers** (63) and one M10 **Nylock Nut** (66).
- (d) Install **Pulley** No.3 (31) to **Upper Cross Beam** (09) using one M10x45mm **Hex Bolt** (58), two M10 **Washers** (63) and one M10 **Nylock Nut** (66). Attach the bolt end of **Upper Cable** (52) to **Selector Shaft** (07) using one **Plastic Washer** (68), attach the other end of **Upper Cable** (52) to **High Pull** (14) using one **Pothook** (47).
- (e) Install **Pulley** No.4 (31) to **Pulley U** (17) using one M10x45mm **Hex Bolt** (58), two M10 **Washers** (63) and one M10 **Nylock Nut** (66).

2. Assembly The Cable 2720mm (51)

- (a) Attach both end of **Cable** 2720mm (51) to **Press Arm** (R) (10) and **Press Arm** (L) (11) using two **Round Plug** (46).
- (b) With **Cable** 2720mm (51) in groove of **Pulley** (31) thread **Cable** (51) through brackets on **Main Frame** (03).
- (c) Install **Pulley** No.10 and No.12 (31) to **Volitant U** (19) using two M10x45mm **Hex Bolts** (58), four M10 **Washers** (63) and two M10 **Nylock Nut** (66).
- (d) Install **Pulley** No.11 (31) and **Reverse U** (18) using one M10x45mm **Hex Bolt** (58), two M10 **Washers** (63) and one M10 **Nylock Nut** (66).

3. Assembly The Gable 3750mm (50)

- (a) With the **Cable** 3750mm (50) in groove of **Pulley** (31) through **Leg Extension Frame** (05).
- (b) Install **Pulley** No.5 (31) with two **Pulley Fastness Bush** (small) (38) to **Leg Extension Frame** (05) using one M10x60mm **Hex Bolt** (57), two M10 **Washers** (63) and one M10 **Nylock Nut** (66).
- (c) Install **Pulley** No.6 (31) with two **Pulley Fastness Bush** (small) (38) to **Front Support Frame** (04) using one M10x60mm **Hex Bolt** (57), two M10 **Washers** (63) and one M10 **Nylock Nut** (66).
- (d) Install **Pulley** No.7 (31) with two **Pulley Fastness Bush** (Big) (37) to **Main Frame** (3) using one M10x65mm **Hex Bolt** (56), two M10 **Washers** (63) and one M10 **Nylock Nut** (66).
- (e) Install **Pulley** No.8 (31) and **Reverse U** (18) using one M10x45mm **Hex Bolt** (58), two M10 **Washers** (63) and one M10 **Nylock Nut** (66).
- (f) Install **Pulley** No.9 (31) to **Front Base Frame** (01) using one M10x45mm **Hex Bolt** (58), two M10 **Washers** (63) and one M10 **Nylock Nut** (66).
- (g) Install **Pulley** No.13 (31) to **Pulley U** (17) using one M10x45mm **Hex Bolt** (58), two M10 **Washers** (63) and one M10 **Nylock Nut** (66). Attach the end of **Cable** 3750mm (50) to **Front Base Frame** (01) using one **Pothook** (47), one **Chain** (53), one M8x40mm **Hex Bolt** (61), two M8 **Washer** (64) and one M8 **Nylock Nut** (67).
- (h) Attach the **Low Pull** (13) or **Ankle Strap** (43) to the other end of **Cable** 3750mm (50) using two **Pothooks** (47) and one **Chain** (53).

NOW GO BACK OVER AND TIGHTEN ALL NUTS AND BOLTS.

ASSEMBLY STEPS

NO.1

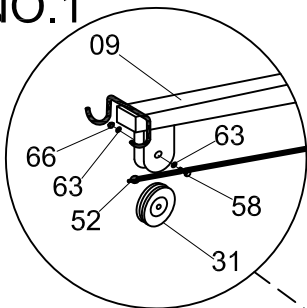

NO.2

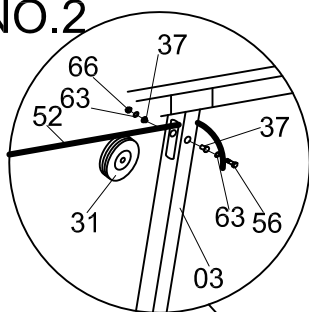

NO.3

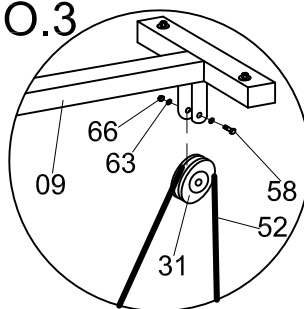

NO.4&13

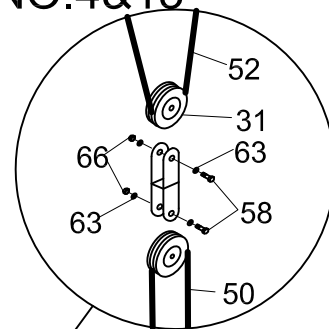

NO.11&8

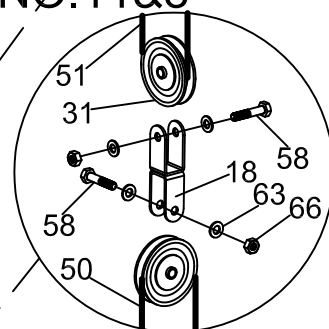

NO.10&12

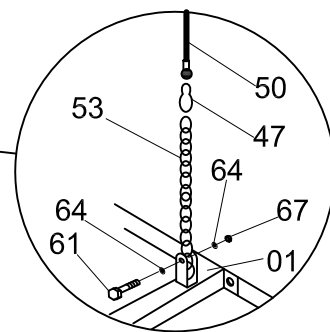
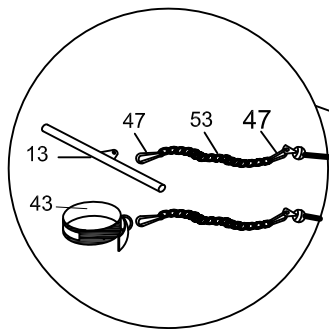
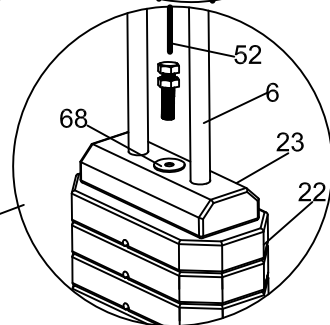
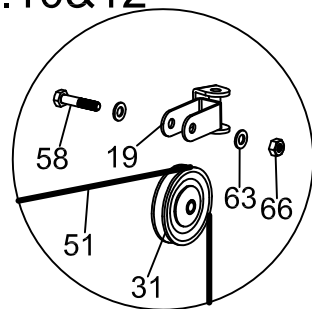

NO.5

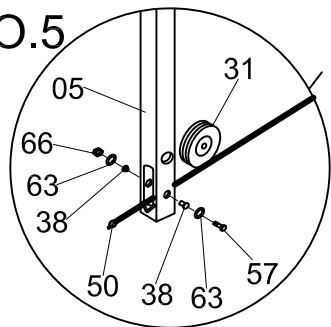

NO.6

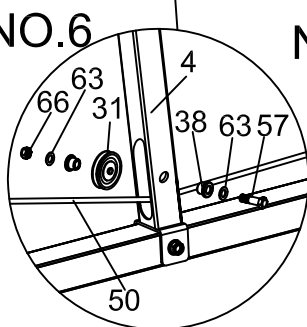

NO.7

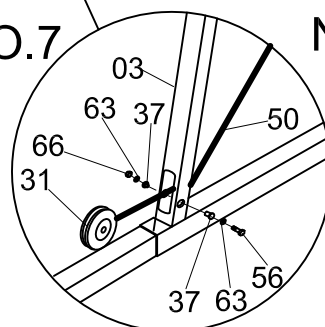



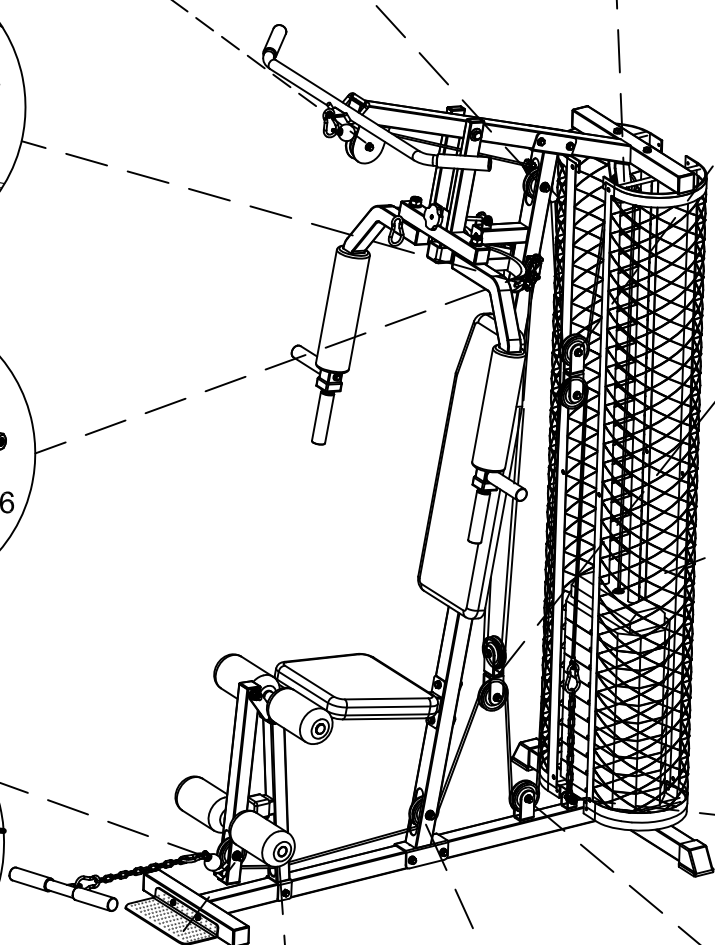
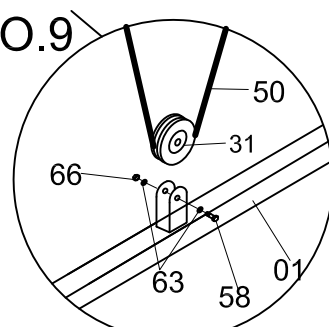





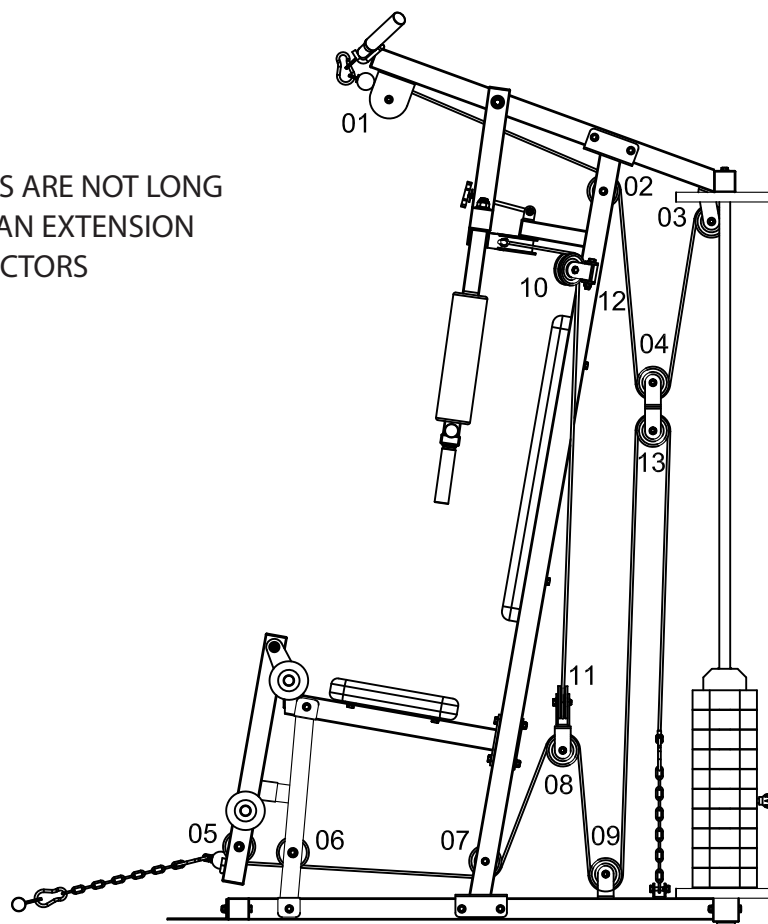

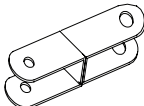
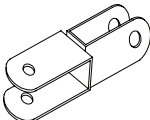
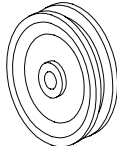

NO.9

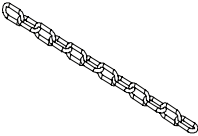

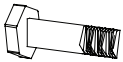
ASSEMBLY STEPS

IF YOU FIND THAT THE CABLES ARE NOT LONG ENOUGH, USE THE CHAIN AS AN EXTENSION WITH SNAP HOOK AS CONNECTORS





 <p>HG2-17 Pulley U 1 pc</p>	 <p>HG2-18 Reverse U 1 pc</p>	 <p>HG2-31 Pulley 13 pcs</p>	 <p>HG2-37 Pulley Fastness Bush (big) 4 pcs</p>
 <p>HG2-38 Pulley Fastness Bush (small) 4 pcs</p>	 <p>HG2-47 Pothook 4 pcs</p>	 <p>HG2-53 Chain 2 pcs</p>	 <p>HG2-56 Hex Bolt (M10 x 65mm) 2 pcs</p>
 <p>HG2-57 Hex Bolt (M10 x 60mm) 2 pcs</p>	 <p>HG2-58 Hex Bolt (M10 x 45mm) 9 pcs</p>	 <p>HG2-61 Hex Bolt (M8 x 40mm) 1 pc</p>	 <p>HG2-63 Washer (M10) 26 pcs</p>
 <p>HG2-64 Washer (M8) 2 pcs</p>	 <p>HG2-66 Nylock Nut (M10) 13 pcs</p>	 <p>HG2-67 Nylock Nut (M8) 1 pc</p>	 <p>HG2-68 Plastic Washer 1 pc</p>

ASSEMBLY STEPS

STEP 7

- Attach the **Convoy Connect** (70) on the middle of each **Convoy** (69) using four M6x15mm **Hex Bolt** (71), eight M6 **Washers** (72) and four M6 **Nylock Nuts** (73).
- Attach the **Convoy** (69) to **Back Base Frame** (02) and **Upper Cross Beam** (09) using eight M6x15mm (71), sixteen M6 **Washers** (72) and eight M6 **Nylock Nuts** (73).

No.	Description	Q'ty
HG2-71	 Hex Bolt (M6x15mm)	12
HG2-72	 Washer (M6)	24
HG2-73	 Nylock Nut (M6)	12

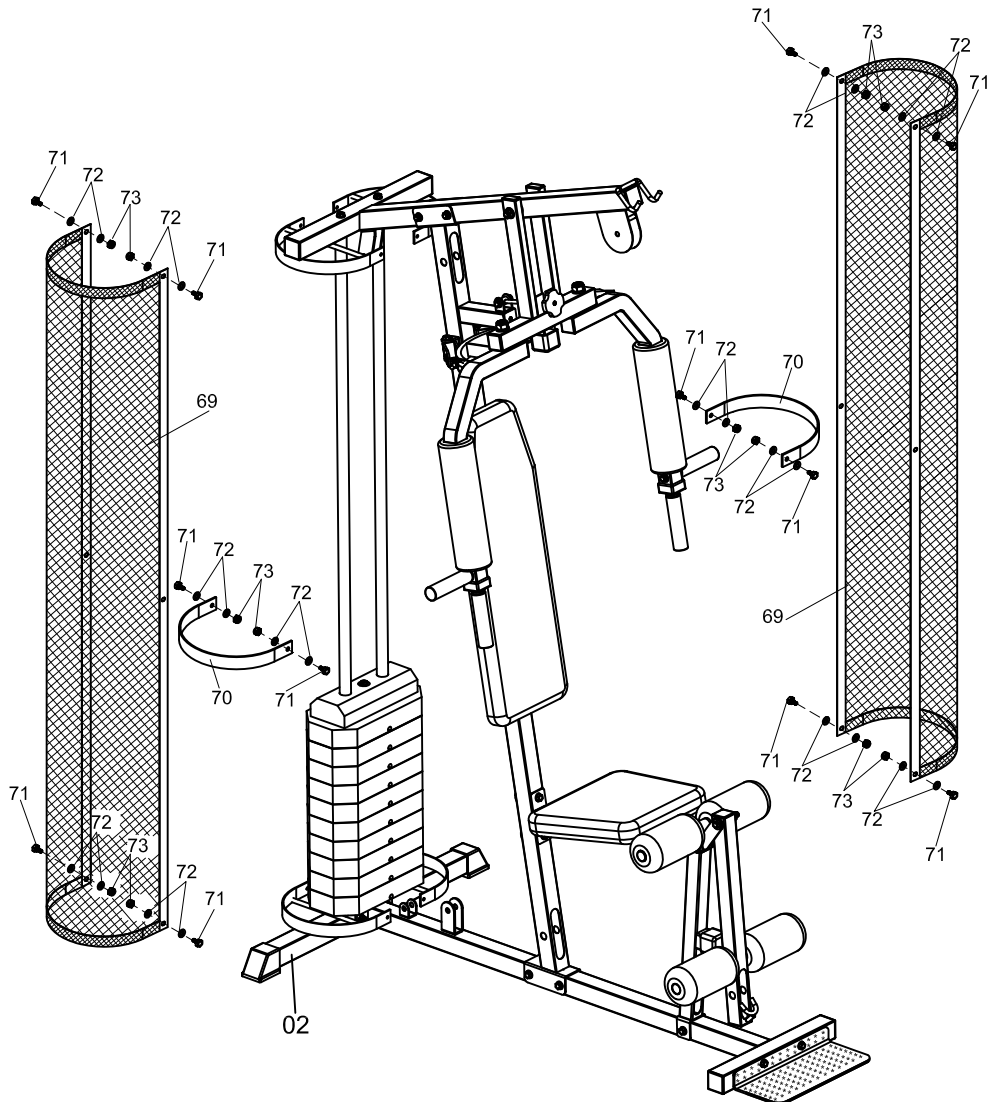

EXPLODED DRAWING

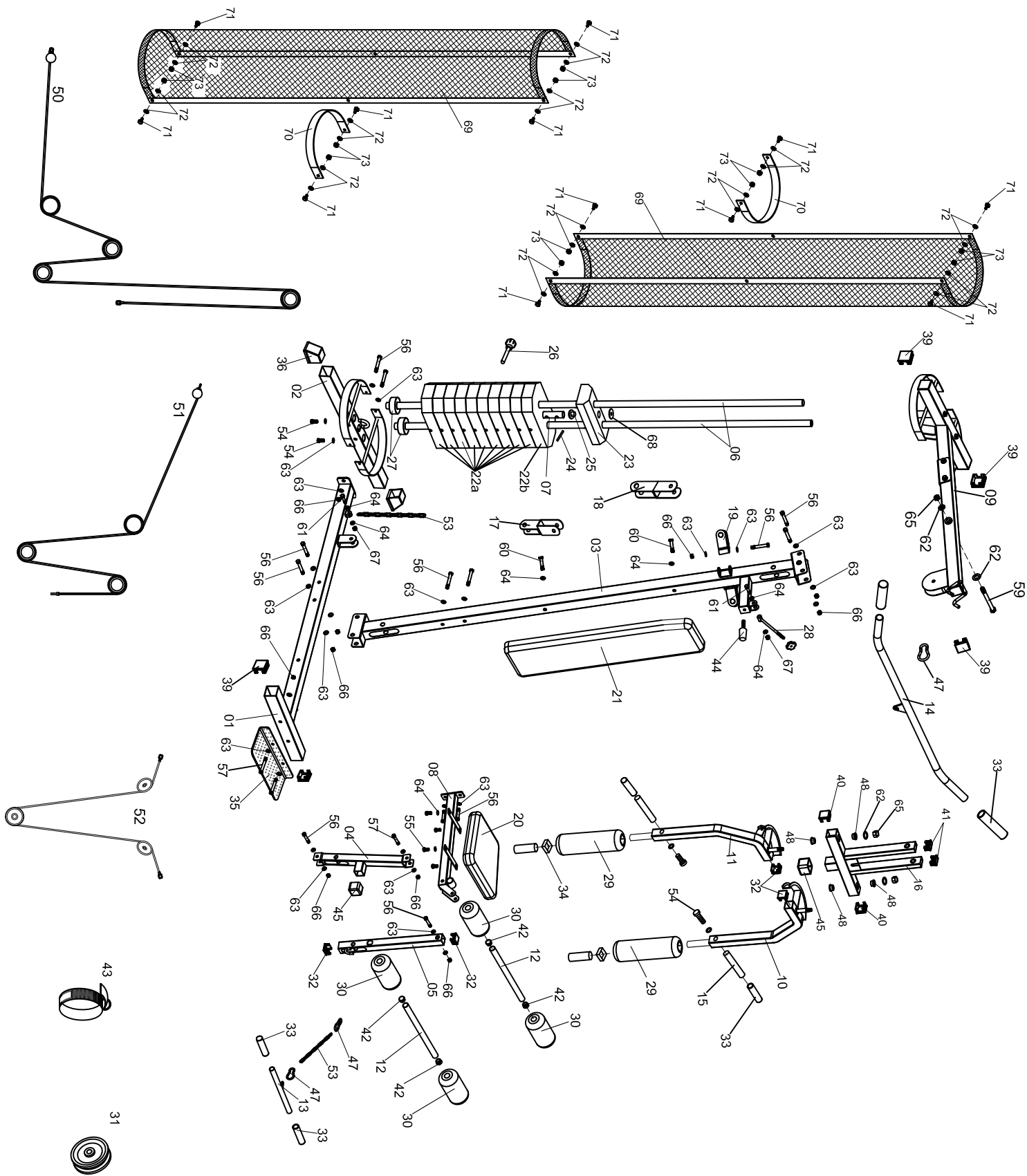

PARTS LIST

No.	Description	Q'ty	No.	Description	Q'ty
HG2-01	Front Base Frame	1	HG2-37	Pulley Fastness Bush (big)	4
HG2-02	Back Base Frame	1	HG2-38	Pulley Fastness Bush (small)	4
HG2-03	Main Fame	1	HG2-39	Square End Plug (45mm)	5
HG2-04	Front Support Frame	1	HG2-40	Square End Plug (40mm)	2
HG2-05	Leg Extension Frame	1	HG2-41	End Plug (40 x 20 mm)	2
HG2-06	Weight Guide Tube	2	HG2-42	End Plug (ø25)	4
HG2-07	Selector Shaft	1	HG2-43	Ankle Strap	1
HG2-08	Seat Frame	1	HG2-44	Rubber Bumper	1
HG2-09	Upper Cross Beam	1	HG2-45	Square Outside-end Plug (38mm)	2
HG2-10	Press Arm (Right)	1	HG2-46	Round Plug	2
HG2-11	Press Arm (Left)	1	HG2-47	Pothook	4
HG2-12	Foam Pipe	2	HG2-48	Oil Bush (BIG)	4
HG2-13	Low Pull	1	HG2-49	Oil Bush (small)	2
HG2-14	High Pull	1	HG2-50	Cable (3750mm)	1
HG2-15	Hand Bar	2	HG2-51	Cable (2720mm)	1
HG2-16	Press bar	1	HG2-52	Cable (2330mm)	1
HG2-17	Pulley U	1	HG2-53	Chain	2
HG2-18	Reverse U	1	HG2-54	Hex Bolt (M10 x 20mm)	6
HG2-19	Volitant U	2	HG2-55	Hex Bolt (M8 x 15mm)	4
HG2-20	Seat Cushion	1	HG2-56	Hex Bolt (M10 x 65mm)	13
HG2-21	Back Cushion	1	HG2-57	Hex Bolt (M10 x 60mm)	6
HG2-22a	Weight Plate 6.8 KG	9	HG2-58	Hex Bolt (M10 x 45mm)	9
HG2-22b	Weight Plate 4.5 KG	1	HG2-59	Hex Bolt (M12 x 120mm)	1
HG2-23	Top Weight Plate	1	HG2-60	Hex Bolt (M8 x 65mm)	2
HG2-24	Selector Shaft Pin (ø10 x 56mm)	1	HG2-61	Hex Bolt (M8 x 40mm)	2
HG2-25	Selector Shaft Bush	1	HG2-62	Washer (M12)	4
HG2-26	Weight Selector Pin	1	HG2-63	Washer (M10)	62
HG2-27	Rubber Cushion	2	HG2-64	Washer (M8)	10
HG2-28	Press Pin	1	HG2-65	Nylock Nut (M12)	3
HG2-29	Big Foam	2	HG2-66	Nylock Nut (M10)	28
HG2-30	Small Foam	4	HG2-67	Nylock Nut (M8)	2
HG2-31	Pulley	13	HG2-68	Plastic Washer	1
HG2-32	Square End Plug (38mm)	4	HG2-69	Convoy	2
HG2-33	Hand Bar Grip	8	HG2-70	Convoy Connect	2
HG2-34	Middle-empty Plug	2	HG2-71	Hex Bolt (M6 x 15mm)	12
HG2-35	Base Plate	1	HG2-72	Washer (M6)	24
HG2-36	Outside-end Plug (45mm)	2	HG2-73	Nylock Nut (M6)	12

IMPLIED WARRANTY

The importer of this machine assures that this device is manufactured with high quality materials.

The prerequisite for the implied warranty is the proper setup in accordance with the operating instructions. Improper use and/or incorrect transportation can void the warranty.

The implied warranty is valid for **1 year**, beginning from the date of purchase. For eventual defects please contact the dealer of this product within the guarantee period .

The warranty applies to the following parts
(as far as included in the scope of delivery):

Frame, Cable, Electronic Devices, Wheels, Pedals

The guarantee does not cover:

- Damage effected by outer force
- Intervention by unauthorized parties
- Incorrect handling of the product
- Non-compliance of the operating instructions

Wear parts and expendable parts are also not covered.

The device is only intended for home use. The warranty does not apply to commercial use of any kind.

Manufactured by:

**Gymstick International Oy Ratakartijankatu 11
15170 Lahti, FINLAND**